

RDCD25SK

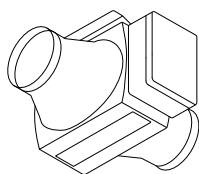

4BRF



Optional - ECOFILTRO PLUS

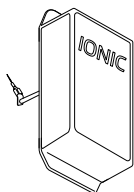

Optional - IONIC

UNITÀ DI RECUPERO CALORE DOMESTICA CENTRALIZZATA AD ALTISSIMA EFFICIENZA REGOLAZIONE PLUG AND PLAY WIRELESS INCLUSA BY-PASS AUTOMATICO INCLUSO INSTALLAZIONE ORIZZONTALE-VERTICALE-DESTRA-SINISTRA

Recuperatore di calore: in controcorrente interamente realizzato in materiale plastico.

Struttura: autoportante in PPE a tenuta completa di sistema estrazione filtri e drenaggio condensa.

Ventilatori: plug fan con motore EC Brushless a semplice aspirazione.

Filtri: le unità sono provviste di serie con celle filtranti ondulate in fibra sintetica classe G4, in opzione filtro efficienza F7 su aria esterna.

DOMESTIC CENTRALIZED HEAT RECOVERY UNIT WITH VERY HIGH EFFICIENCY AND WITH WIRELESS PLUG AND PLAY CONTROL SYSTEM INCLUDED AUTOMATIC BY-PASS INCLUDED INSTALLATION HORIZONTAL-VERTICAL-RIGHT -LEFT

Heat recovery: heat exchanger of the type in countercurrent entirely made of plastic material.

Structure: free standing EPP seal, complete of filters ex traction system and drain condensate.

Fans: plug fan with EC Brushless engine single inlet.

Filters: the units are equipped with standard filter cells synthetic fiber efficiency G4, optional F7 efficiency on fresh air.

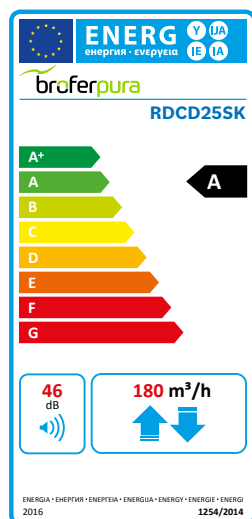

Portata aria (mc/h) Nominal air flow (mc/h)	180
Pressione statica utile (pa) Useful static pressure (pa)	100

DATI PER SINGOLO VENTILATORE | DATA FOR EACH FAN

Potenza nominale (w) Installed power (W)	27
Giri (1/min) Round (1/MIN)	3700
I nominale (A) Current (A)	0.27
Tensione (V) Rated voltage (V)	230
Frequenza (Hz) Frequency (HZ)	50
Velocità (nr) Speed (nr)	3+(1 booster)

FILTRI | FILTERS

Efficienza Efficiency Standard	G4 ISO COARSE > 65 %
Efficienza Efficiency Optional	F7 ISO e PM1 > 65 %



DISEGNI | DRAWINGS

PESO | WEIGHT: 14 kg

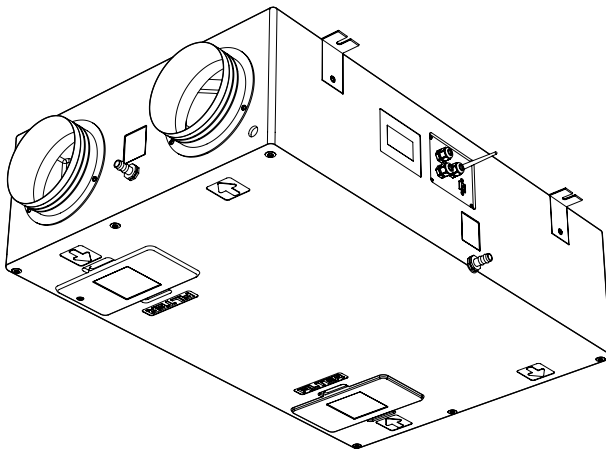

Vista dal basso | Bottom View

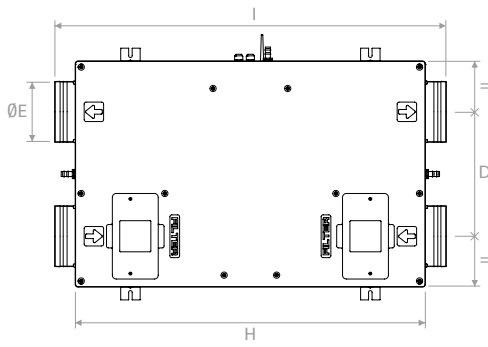

Vista interna | Internal view

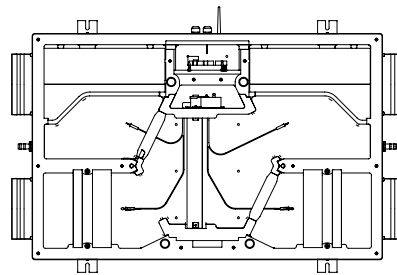

Vista laterale | Side view

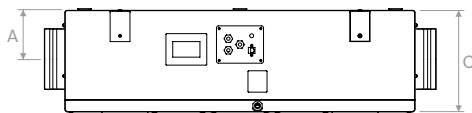

Vista frontale | Front view

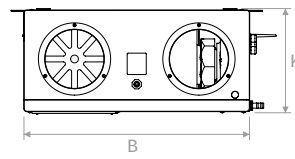

Vista in pianta | Plan view

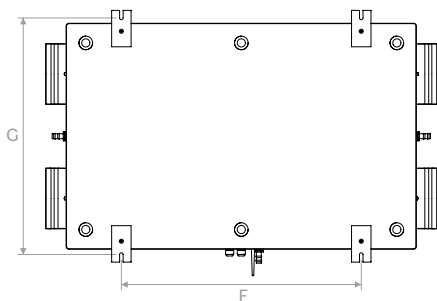

	A	B	C	D	ØE	F	G	H	I	K
mm	125	580	260	320	156	617	609	900	1005	268



PRESTAZIONI CERTIFICATE EN 13141:7:2011 | PERFORMANCE EN 13141:7:2011 CERTIFIED

Pressione statica utile
Useful static pressure
① ③

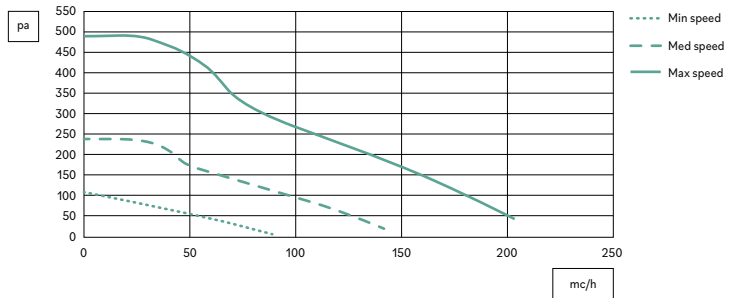

Potenza specifica ventilatore
S.F.P.
②

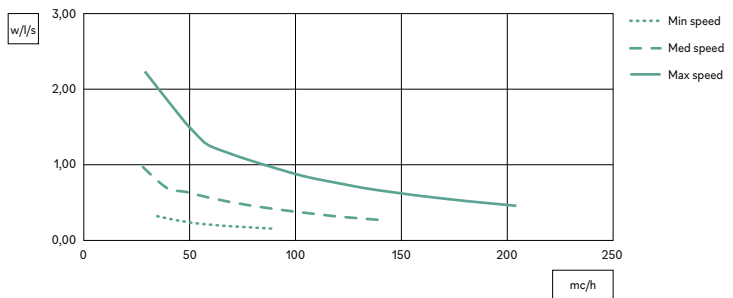

SCAMBIATORE CERTIFICATO EN 308 | HEAT EXCHANGER EN 308 CERTIFIED

Diagramma efficienza estiva
Aria esterna: 32 °C / 50 % U.R.
Aria ambiente: 26 °C / 50 % U.R.
Summer efficiency chart
Fresh air: 32 °C / 50 % R.H.
Return air: 26 °C / 50 % R.H.



Diagramma efficienza invernale
Aria esterna: -5 °C / 80 % U.R.
Aria ambiente: 20 °C / 50 % U.R.
Winter efficiency chart
Fresh air: -5 °C / 80 % R.H.
Return air: 20 °C / 50 % R.H.



① Dati con filtri G4 standard | Data with standard G4 filters
② Dati per singolo ventilatore | Data for single fan
③ Perdite di carico filtro efficienza F7 80 pa alla massima portata con filtro pulito
Air pressure drop with F7 efficiency filter 80 pa at maximum air flow rate with clean filter

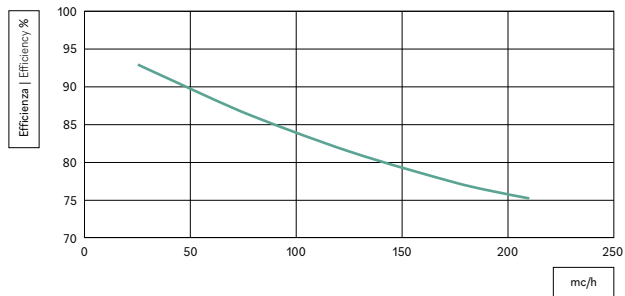
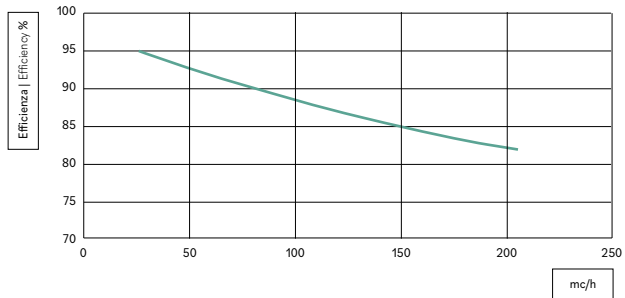

CONFIGURAZIONE | CONFIGURATION

INSTALLAZIONE VERTICALE A PARETE | VERTICAL WALL INSTALLATION

Tipo | Type A (Standard)

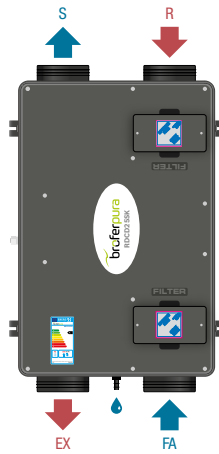

Tipo | Type B

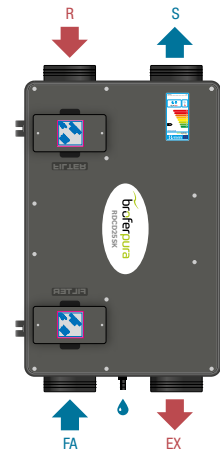

INSTALLAZIONE ORIZZONTALE A SOFFITTO | HORIZONTAL CEILING INSTALLATION

Tipo | Type A (Standard)

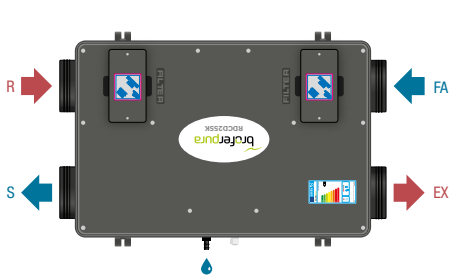

Tipo | Type A1 (Standard)

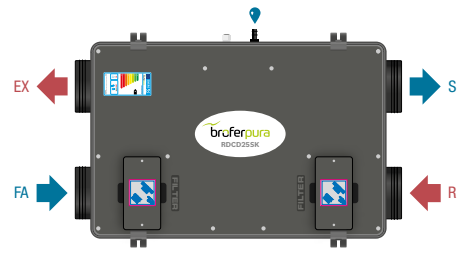

Tipo | Type B

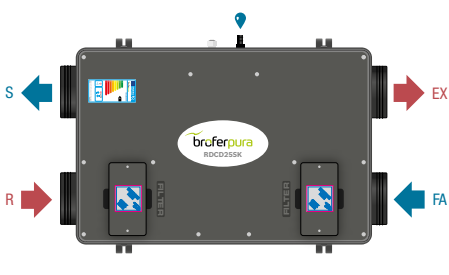

Tipo | Type B1



- Legenda | Legend**
 EX = espulsione | exhaust air
 R = ripresa | return
 FA = aria esterna | fresh air
 S = mandata | supply

DICHIARAZIONE DI PRESTAZIONE DELL'UNITÀ DI RECUPERO DEL CALORE

DECLARATION OF PERFORMANCE HEAT RECOVERY UNIT

Nome o denominazione commerciale del fabbricante Supplier name or trade mark	BROFER								
Identificativo del modello del fornitore e opzioni installate Supplier Model Identifier and options installed	RDCD25SK + 4BRF			RDCD25SK + RHRF / CO2RF			RDCD25SK + RHRF / CO2RF locali-local		
Clima di riferimento Reference climate	Temperato Temperate	Freddo Cold	Caldo Hot	Temperato Temperate	Freddo Cold	Caldo Hot	Temperato Temperate	Freddo Cold	Caldo Hot
SEC in [kWh/(m ² a)] per ogni tipo di clima (temperato, caldo, freddo) for each type of climate (temperate, hot, cold)	-35,83	-76,93	-12,92	-38,59	-80,56	-14,55	-41,80	-84,92	-17,10
SEC Class	A	A+	E	A	A+	E	A	A+	E
Tipologia dichiarata dell'unità di ventilazione Declared Typology	UVR-B Bidirezionale UVR-B Bidirectional			UVR-B Bidirezionale UVR-B Bidirectional			UVR-B Bidirezionale UVR-B Bidirectional		
Tipo di azionamento installato Type of drive installed	Azionamento a velocità multiple Multi-speed drive			Velocità variabile Variable speed			Velocità variabile Variable speed		
Tipo di sistema di recupero del calore Type of heat recovery	a recupero Recuperative			a recupero Recuperative			a recupero Recuperative		
Efficienza termica ¹ Thermal efficiency ¹	81,1%			81,1%			81,1%		
Portata massima in [m ³ /h] ² Maximum flow rate in [m ³ /h] ²	180			180			180		
Potenza elettrica complessiva massima portata [W] Maximum electric Power in [W]	60			60			60		
Livello di potenza sonora (LWA) in [dB(A)] ³ Sound Power Level (LWA) in [dB(A)] ³	46			46			46		
Portata di riferimento in [m ³ /h] ⁴ Reference flow rate [m ³ /h] ⁴	126			126			126		
Differenze di pressione di riferimento [Pa] Reference pressure difference in [Pa]	50			50			50		
SPI in [W/m ³ /h] ⁵	0,21			0,21			0,21		
Fattore di controllo e tipologia Control factor and typology	1			0,85			0,65		
Percentuale massima di trafileamento interno [%] ⁶ Declared maximum internal leakage [%] ⁶	1,2			1,2			1,2		
Percentuale massima di trafileamento esterno [%] ⁶ Declared maximum external leakage [%] ⁶	2,5			2,5			2,5		
Indirizzo Internet con costruzioni Internet address for pre/dis-assembly instruction	www.broferpura.it								

- 1: Efficienza in conformità a EN13141-7:2010 alla portata di riferimento a 50 Pa | Efficiency according EN13141-7:2010 at reference flow at 50 Pa
2: Portata massima a 100 Pa di pressione esterna | Maximum flow at 100 Pa external pressure
3: Irraggiamento dalla cassa alla portata di riferimento a 50 Pa di pressione esterna | Casing radiation at reference flow rate at 50 Pa external pressure
4: La percentuale della portata di riferimento è del 70% della portata massima a 50 Pa di pressione esterna in conformità a EN13141-7:2010
Reference flow rate is 70% of maximum flow at 50 Pa external pressure according EN13141-7:2010
5: In conformità a EN13141-7:2010 alla portata di riferimento | According EN13141-7:2010 at reference flow rate
6: In conformità a EN13141-7:2010 | According EN13141-7:2010
SEC: Consumo energetico specifico | Specific Energy Consumption





PREZZI | PRICES

Modello Model	Descrizione Description	€
RDCD25SK		-
RDCD25SKE*		-
RDCD25SKI**	Dimensioni Sizes pag. 206	-
KFTR060A	Kit filtri ricambio (2 pz) efficienza G4 Replacement filter kit (2 pcs) efficiency G4	-
FTRLET483	Filtro ricambio efficienza F7 Replacement filter efficiency F7	-

* Versione con scambiatore entalpico | Version with enthalpic heat exchanger

** Versione completa con ionizzatore IONIC | Version complete with IONIC ionizer

	4BRF	RHRF	C02RF	MODBUSRF	APPRF	DSPRF
Modello Model						
Controllo velocità Speed control	●	●	●		●	●
By-pass	●	●	●		●	●
Antigelo Defrost protection	●	●	●		●	●
Intasamento filtri Clogged filters	●	●	●		●	●
Controllo umidità Humidity control		●				
Controllo CO ₂ CO ₂ control			●			
Funzione booster Booster function	●				●	●
Trasmittitore MODBUS MODBUS gate way				●	●	
Impostazione velocità Speeds setting						●
ON/OFF						●
Allarmi puntuali Punctual alarms	●	●	●			●
€	incluso nel prezzo included in the price	-	-	-	-	-

EHRDCD25SK

MODULO ALLOGGIAMENTO INCASSO UNITÀ | UNIT MODULE BUILT-IN THE WALL

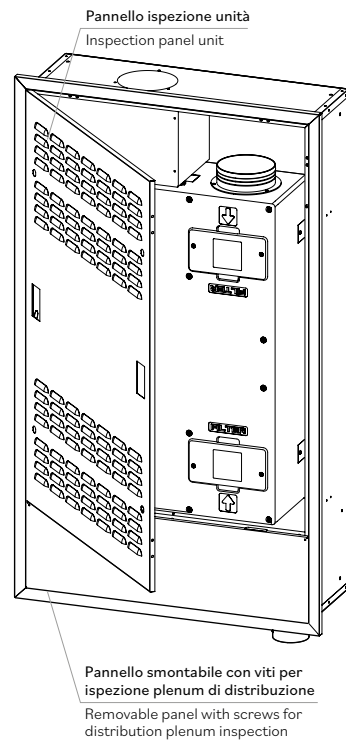

Modulo di alloggiamento esterno da incassare a muro realizzato in acciaio zincato (verniciato RAL 9003 opaco su richiesta) con isolamento termico interno. Adatto per installazione di RDCD25SKE.

- Non richiede l'installazione di un sistema di drenaggio della condensa.
- Installazione del punto di espulsione aria sia nella parte superiore che in quella inferiore.
- Posizionamento del plenum di distribuzione (mandata e ripresa) sia nella parte superiore che in quella inferiore.
- Posizionamento del plenum di distribuzione (mandata e ripresa) sia assiale che perpendicolare rispetto alla parete di alloggiamento.
- Apertura della porta a destra, sinistra o ad incasso modificabile in fase di installazione.

External housing module to be embedded in the wall made of galvanized steel (painted RAL 9003 on request) with internal thermal insulation. Suitable for installation of RDCD25SKE.

- It does not require the installation of a condensate drainage system.
- Installation of the air exhaust point in both the upper and lower part.
- Positioning of the distribution plenum (supply and return) both in upper and lower part.
- Positioning of the distribution plenum (supply and return) both axial and perpendicular to the housing wall.
- Opening of the door to the left, to the right or recessed modifiable during installation.



DISEGNI | DRAWINGS

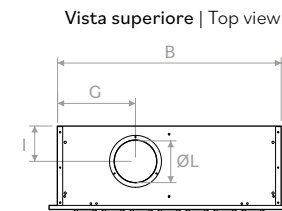
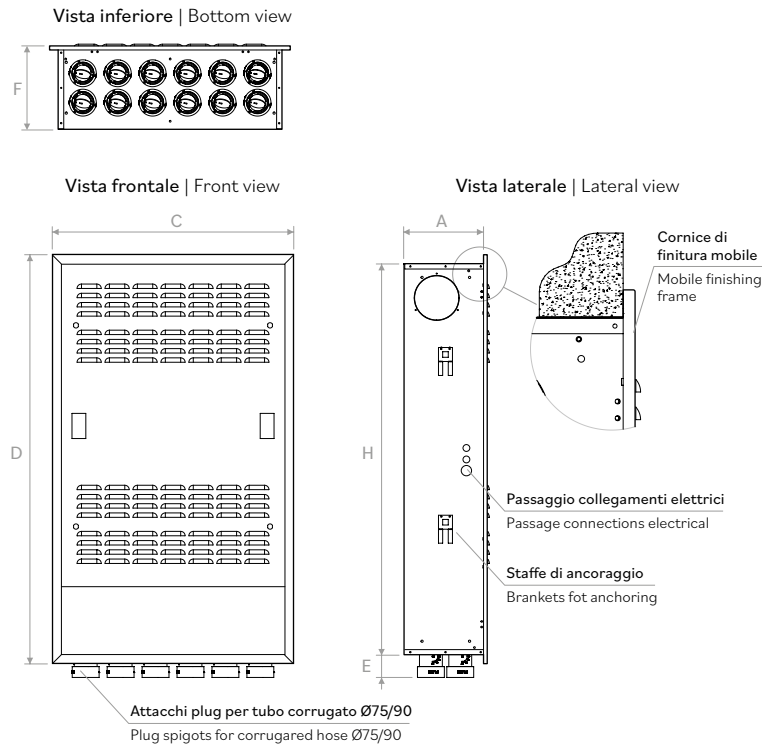

SOLUZIONI DI APERTURA PANNELLO EFFETTUABILI IN FASE DI MONTAGGIO
SOLUTIONS OF PANEL OPENING FEASIBLE DURING INSTALLATION

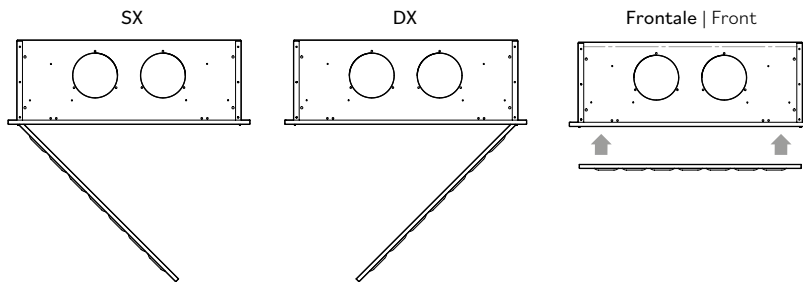

	A	B	C	D	E	F	G	H	I	ØL
mm	285	800	865	1465	80	300	279	1400	126	160

POSSIBILI CONFIGURAZIONI
POSSIBLE CONFIGURATIONS

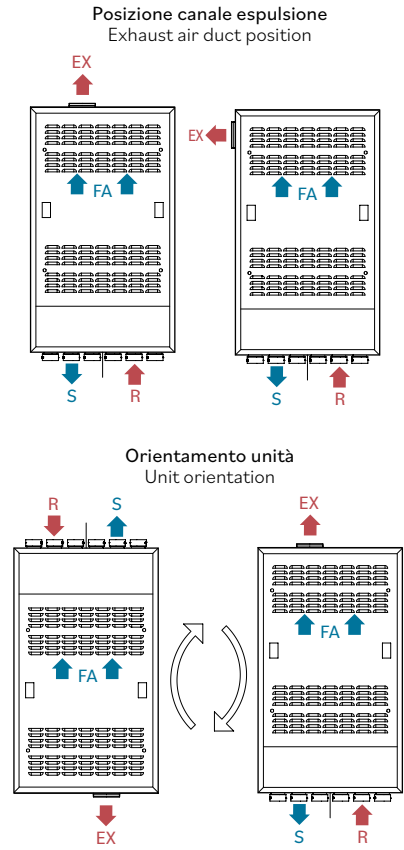

Posizione attacchi mandata/ripresa
Spigots position supply/return

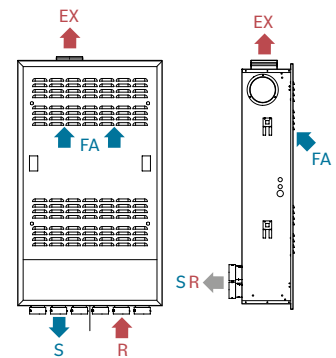

Legenda | Legend
 EX = espulsione | exhaust air
 R = ripresa | return
 FA = aria esterna | fresh air
 S = mandata | supply

PREZZI | PRICES

Modello Model	€
EHRDCD25SK	-
EHRDCD25SK9003*	-

* Versione verniciata RAL 9003 opaco | Version RAL 9003 matt painted



EHCRDCD25SK

MODULO ALLOGGIAMENTO A FILO MURO UNITÀ | HOUSING UNIT MODULE FLUSH WITH THE WALL

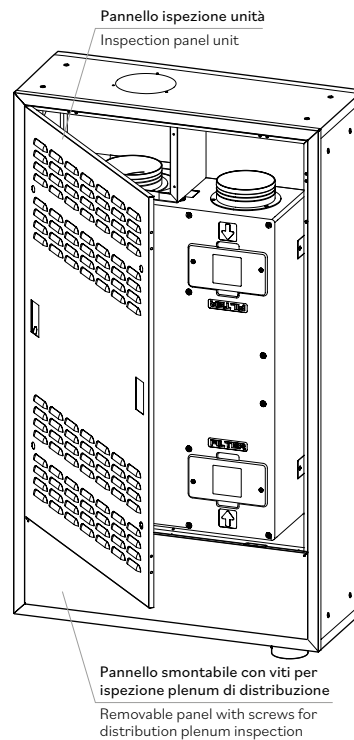

Modulo di alloggiamento esterno a filo a muro realizzato in acciaio zincato (verniciato RAL 9003 opaco su richiesta) con isolamento termico interno ed ulteriore mantello esterno in acciaio zincato con interposizione di lana minerale spessore 30 mm. Adatto per installazione di RDCD25SKE.

- Non richiede l'installazione di un sistema di drenaggio della condensa.
- Installazione del punto di espulsione aria sia nella parte superiore che in quella inferiore.
- Posizionamento del plenum di distribuzione (mandata e ripresa) sia nella parte superiore che in quella inferiore.
- Posizionamento del plenum di distribuzione (mandata e ripresa) perpendicolare rispetto alla parete di alloggiamento.
- Apertura della porta a destra, sinistra o ad incasso modificabile in fase di installazione.

External housing module flush with the wall made of galvanized steel (painted RAL 9003 matt on request) with internal thermal insulation and additional external casing in galvanized steel with 30 mm thick mineral wool interposition. Suitable for installation of RDCD25SKE.

- It does not require the installation of a condensate drainage system.
- Installation of the air exhaust point in both upper and lower part.
- Positioning of the distribution plenum (supply and return) both in the upper and lower part.
- Positioning of the distribution plenum (supply and return) perpendicular to the housing wall.
- Opening of the door to the left, to the right or recessed modifiable during installation.



DISEGNI | DRAWINGS

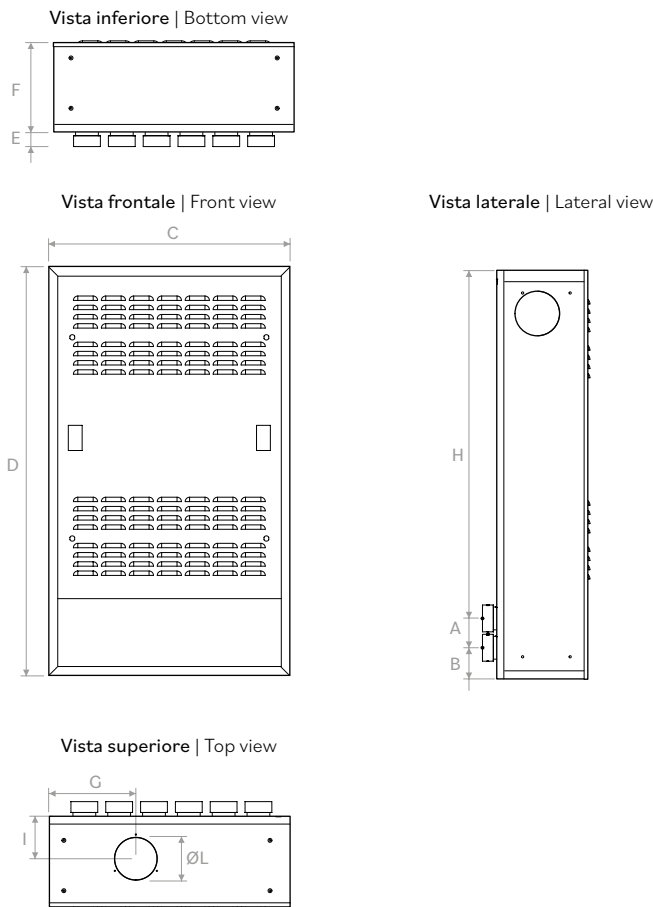

**POSSIBILI CONFIGURAZIONI
POSSIBLE CONFIGURATIONS**

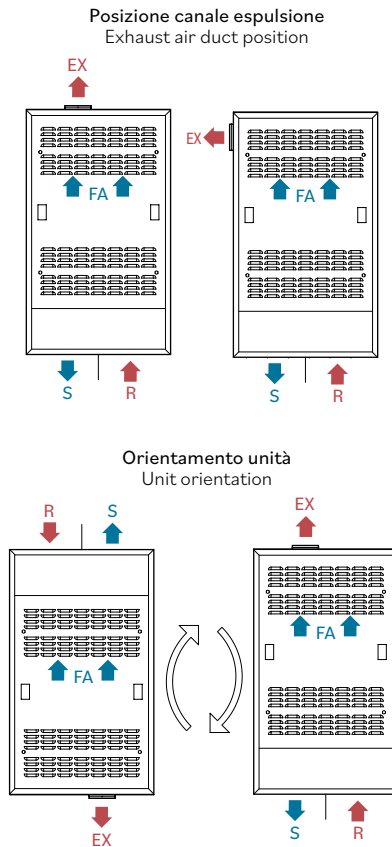

SOLUZIONI DI APERTURA PANNELLO EFFETTUABILI IN FASE DI MONTAGGIO
SOLUTIONS OF PANEL OPENING FEASIBLE IN THE MOUNTING PHASE

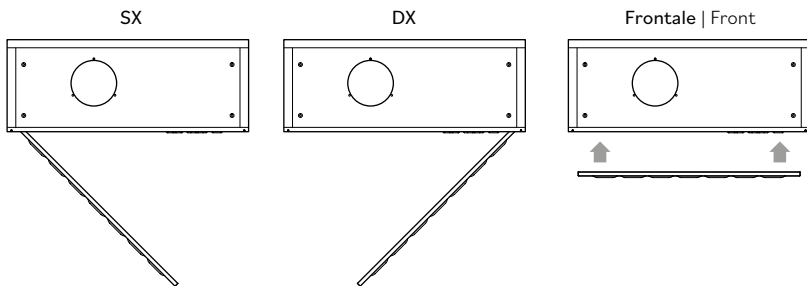

**Posizione attacchi mandata/ripresa
Spigots position supply/return**

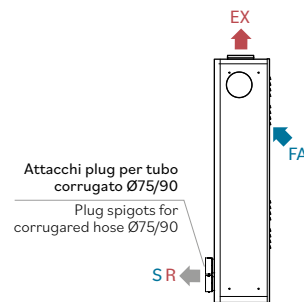

Legenda | Legend
 EX = espulsione | exhaust air
 R = ripresa | return
 FA = aria esterna | fresh air
 S = mandata | supply

	A	B	C	D	E	F	G	H	I	ØL
mm	105	114	865	1465	51	330	310	1246	156	160

PREZZI | PRICES

Modello Model	€
EHCRDCD25SK	-
EHCRDCD25SK9003*	-

* Versione verniciata RAL 9003 opaco | Version RAL 9003 matt painted

