

Haier

HVAC Solutions

Professional, Smart &
Healthy Air Solutions

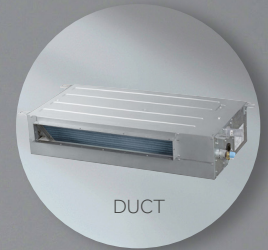

MULTI

Combine up to 5 indoor units

Haierhvac.eu

Features

Residential MultiSplit Inverter



Introduction

Haier's Multi Split system enables you to experience climate comfort in every room.

A Multi system allows up to 5 indoor units to operate from a single outdoor unit, thereby reducing installation space and costs. All indoor units can be controlled independently and does not need to be installed at the same time, the system can be future proofed to allow up to 5 indoor units to one outdoor unit.

Haier's range of indoor units caters for a wide variety of applications, this includes, wall mounted, concealed ceiling, cassettes and floor standing units. These units are available in range of capacities which enables you to accurately size the system according to the needs of the room.

MultiSplit Unit Connectivity

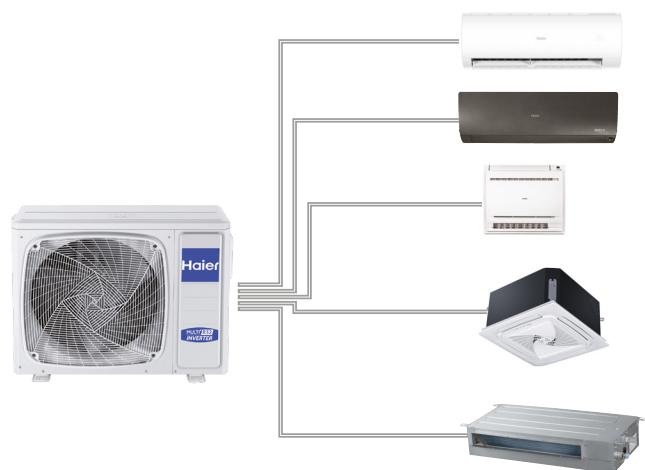

Outdoor Unit



R32 Refrigerant



Silence



Easy Installation

Haier

Features



SELF-CLEAN

Freezes the evaporator with moisture in the air and removes dirt during the defrost process, ensuring healthy air output. Our Self Clean technology is the first of its kind to integrate the self-cleaning function of both the evaporator and the condenser.



HON WI-FI

Enables you to take control of all the Haier group appliances in your Smart Home from a single app on your smartphone or tablet. The hOn app allows you to manage all the basic functions and much more.

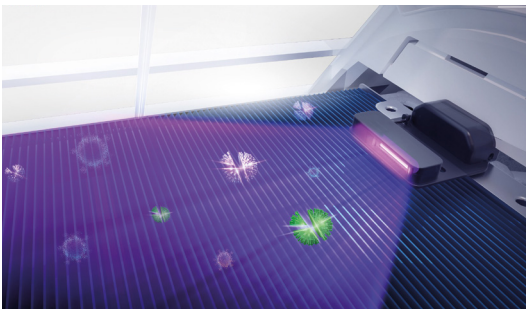

UVC PRO

Inhibits the reproduction of bacteria, by breaking down hydron and oxygen molecule and generates ionic group which inhibits bacteria and sterilises virus after contacting. The module was independently tested by Texcell and inhibits SARS-CoV-2, with an efficiency up to 99.998% in 1 hour (Expert).



EASY INSTALLATION

Installation is simplified, with larger workspaces and easy disassembly and maintenance. Pipes and cables can be connected easily thanks to a removable bottom panel.



SILENCE

Optimised design of fan's air ducts, and motors to be able to deliver cooler, more comfortable air with a low noise level for you to enjoy your indoor space.



















































































ECO SENSOR

Detects the condition of air and people's movement in real time, adjusting the operating mode of the air conditioner to improve energy efficiency and optimise the users experience. It uses a double area detection with a maximum angle of 120 degrees and a distance of 8m.

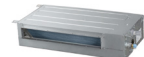
Compatibility

Residential MultiSplit Inverter

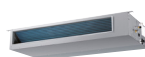
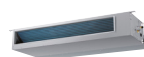
INDOOR UNITS MULTI-SPLIT R32								
SERIES	2,0 kW	2,5 kW	3,5 kW	5,0 kW	7,1 kW			
JADE		 AS25S2SJ1FA-3	 AS35S2SJ1FA-3	 AS50S2SD1FA-3				
	 PM 2.5 Detection				 Wi-Fi control integrated			
NEW EXPERT	 AS20XCAHRA	 AS25XCAHRA	 AS35XCAHRA	 AS50XCAHRA				
						 Wi-Fi control integrated		
FLEXIS PLUS Black & White	 AS20S2SF1FA-MB3	 AS25S2SF1FA-MB3	 AS35S2SF1FA-MB3	 AS50S2SF1FA-MB3	 AS71S2SF1FA-MB3			
	 AS20S2SF1FA-MW3	 AS25S2SF1FA-MW3	 AS35S2SF1FA-MW3	 AS50S2SF1FA-MW3	 AS71S2SF1FA-MW3			
					 Wi-Fi control integrated	 56° Steri-Clean		 UVC Sterilisation
PEARL	 AS20PBAHRA	 AS25PBAHRA	 AS35PBAHRA	 AS50PBAHRA				
			 56° Steri-Clean	 UVC Sterilisation	 Wi-Fi control integrated			

INDOOR UNITS MULTI-SPLIT R32					
SERIES	2,0 kW	2,5 kW	3,5 kW	5,0 kW	7,1 kW
CONSOLE		 AD71S2SM3FA(H)	 AF35S2SD1FA(H)		
	 Silence	 Double Flow	 Compact Design	 Sleep	 NEW Wi-Fi control integrated
CASSETTE 620		 AB25S2SC2FA-1	 AB35S2SC2FA-1	 AB50S2SC2FA-1	
	 Silence	 4Way Independent	 NEW Wi-Fi control integrated	 Fresh Air	 On-Off Card
CASSETTE 360°/ ROUND FLOW					 AB71S2SG1FA
	 Silence	 8Way Independent	 Wi-Fi Optional	 Fresh Air	 Condensate Drain Pump
CEILING FLOOR			 AC35S2SG1FA	 AC50S2SG1FA	 AC71S2SG1FA
	 Silence	 Flow +	 5 Speed Fan	 Fresh Air	 On-Off Card
SLIM DUCT LOW PRESSURE		 AD25S2SS1FA(H)	 AD35S2SS1FA(H)	 AD50S2SS1FA(H)	 AD71S2SS1FA(H)
	 Silence	 Compact Design	 3D	 Condensate Drain Pump	 Flexible Installation
DUCTED MEDIUM PRESSURE			 AD35S2SM3FA(H)	 AD50S2SM3FA(H)	 AD71S2SM3FA(H)
	 Silence	 Compact Design	 3D	 Condensate Drain Pump	 Flexible Installation

Compatibility

Residential MultiSplit Inverter



1:2 2U40S2SM1FA
2U50S2SM1FA-3



1:3 3U55S2SR5FA
3U70S2SR5FA



1:4 4U75S2SR5FA
4U85S2SR5FA



1:5 5U90S2SS5FA
5U105S2SS5FA
5U125S2SN1FA

Outdoor Unit	Model		2U40S2SM1FA	2U50S2SM1FA-3	3U55S2SR5FA	3U70S2SR5FA	4U75S2SR5FA	4U85S2SR5FA	5U90S2SS5FA	5U105S2SS5FA	5U125S2SN1FA
Performance data											
Output power - COOLING	nom (min-max)	KW	(1,00-4,50) 4,00	(1,10-5,60) 5,00	(2,10-7,00) 5,50	(2,40-7,60) 7,00	(2,40-8,70) 7,50	(3,20-9,50) 8,50	(3,20-11,00) 9,00	3,20-10,00 (11,00)	3,20-12,50 (13,80)
Output power - HEATING	nom (min-max)	KW	(1,50-4,80) 4,40	(1,40-6,00) 5,20	(1,70-7,60) 6,80	(2,90-8,50) 7,60	(3,10-10,00) 8,60	(4,40-10,50) 9,60	4,40-10,40 (11,50)	4,40-10,50 (11,50)	4,40-12,70 (14,30)
Absorbed power - COOLING	nom (min-max)	KW	1,00	1,43	1,35	1,84	1,97	2,50	2,79	3,47	3,87
Absorbed power - HEATING	nom (min-max)	KW	1,07	1,40	1,66	1,85	2,15	2,40	2,79	2,82	3,40
Energy class	EER	W/W	4,00	3,45	4,00	3,81	3,80	3,40	3,23	2,88	3,23
	COP	W/W	4,10	3,71	4,10	4,10	4,00	4,00	3,73	3,73	3,73
COOLING Pdesign	35 °C	KW	4,00	5,00	5,50	7,00	7,50	8,00	9,00	10,00	12,50
HEATING Pdesign	(-10 °C)	KW	3,30	4,70	4,70	6,00	6,30	7,00	7,20	8,00	9,50
Energy class	SEER		(++A) 6,50	(++A) 6,50	(+++A) 8,50	(++A) 7,50	(++A) 7,00	(++A) 7,00	(++A) 7,00	(++A) 7,00	(++A) 7,10
	SCOP		(+A) 4,00	(+A) 4,00	(+A) 4,00	(+A) 4,20	(+A) 4,00	(+A) 4,00	(+A) 4,00	(+A) 4,00	(+A) 4,05
Annual Energy Consumption - COOLING		kWh/a	269	269	227	332	379	456	457	537	622
Annual Energy Consumption - HEATING		kWh/a	6451	6451	1678	0122	1792	5032	2441	8892	3346
Outdoor Unit											
Power supply		Ph/V/Hz	1/220 (240/50/60)								
Power cable		N x mm2	3 x 2,5	3 x 2,5	3 x 4,0	3 x 4,0	3 x 4,0	3 x 4,0	3 x 4,0	3 x 4,0	3 x 4,0
Interconnection cable		N x mm2	4 x 1,0	4 x 1,0	4 x 2,5	4 x 2,5	4 x 2,5	4 x 2,5	4 x 2,5	4 x 2,5	4 x 2,5
Air Volume	H	m3/h	2200	2400	3000	3000	4000	4000	4 200	4 200	4 200
Sound power	H	dB	62	63	64	66	68	68	70	70	73
Sound pressure	H	dB(A)	52	53	51	53	55	55	55	55	58
Running current cooling/heating	Max	A	7,3/8,2	9,1/9,1	10,8/9,5	11,9/9,7	14,7/13,5	15,5/14,6	18,2/14,6	18,2/14,6	23,0/18,7
Starting current cooling/heating	Max	A	3,0/3,0	3,0/3,0	4,0/4,0	4,0/4,0	5,0/5,0	5,0/5,0	5,0/5,0	5,0/5,0	5,0/5,0
Net dimensions	WxDxH	mm	800 x 275 x 553	800 x 275 x 553	890 x 340 x 700	890 x 340 x 700	890 x 340 x 700	890 x 340 x 700	920x372x760	920x372x760	950x370x965
Packaging dimensions	WxDxH	mm	954x409x625	954x409x625	1010x455x835	1010x455x835	1010x455x835	1010x455x835	1045x488x890	1045x488x890	1050x485x1170
Net/gross weight		kg	34,0/37,0	36,0/39,0	50,0/59,0	54,0/63,0	61,0/70,0	61,0/70,0	66,0/77,0	66,0/77,0	79,0/91,0
Compressor type			Twin rotary inverter								
Installation data											
Refrigerant			R32	R32	R32	R32	R32	R32	R32	R32	R32
Liquid pipe	Ø	mm (Inch)	(3x1/4) 6,35x2	(3x1/4) 6,35x2	(3x1/4) 6,35x3	(3x1/4) 6,35x3	(4x1/4) 6,35x4	(4x1/4) 6,35x4	(5x1/4) 6,35x5	(5x1/4) 6,35x5	(5x1/4) 6,35x5
Gas pipe	Ø	mm (Inch)	(3x3/8) 9,52x2	(3x3/8) 9,52x2	(3x3/8) 9,52x3	(3x3/8) 9,52x3	(3x3/8+1x1/2) 12,70x9,52+1x3	(3x3/8+2x1/2) 12,70x9,52+2x3			
Standard pipe length without refrigerant charge	m		20	20	30	30	40	40	40	40	50
Maximum pipe length	m		30	30	50	60	70	70	80	80	100
Maximum IU - OU elevation	m		15	15	15	15	15	15	15	15	15
Maximum IU - OU elevation	m		7,5	7,5	7,5	7,5	7,5	7,5	7,5	7,5	7,5
Refrigerant charge in the factory	kg		1,00	1,40	1,40	1,60	1,60	2,20	2,40	2,40	2,50
Refrigerant charge in the factory	TCO2eq		0,68	0,95	0,95	1,08	1,08	1,49	1,62	1,62	1,69
Additional ref. charge over std length	g/m		20	20	20	20	20	20	20	20	20
Outdoor operating limits - COOLING	min-max	°C	43°C--10				46°C--10				
Outdoor operating limits - HEATING	min-max	°C	24°C--15								

- 4,0 kW
- 5,0 kW
- 5,5 kW
- 7,0 kW
- 8,5 kW
- 9,0 kW
- 10,5 kW
- 12,5 kW

Haier

2U40S2SM1FA (2 coupling)

2U50S2SM1FA-3 (2 coupling)

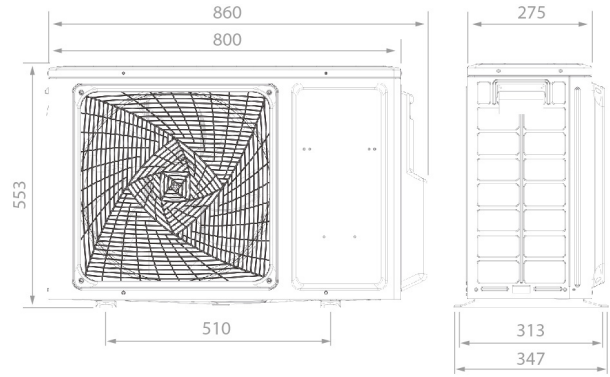
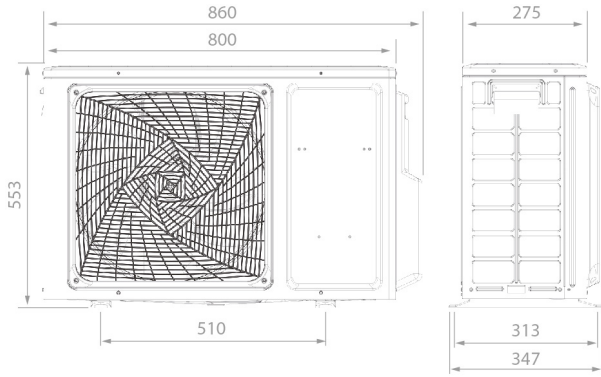

3U55S2SR5FA - 3U70S2SR5FA (3 coupling)

4U75S2SR5FA - 4U85S2SR5FA (4 coupling)

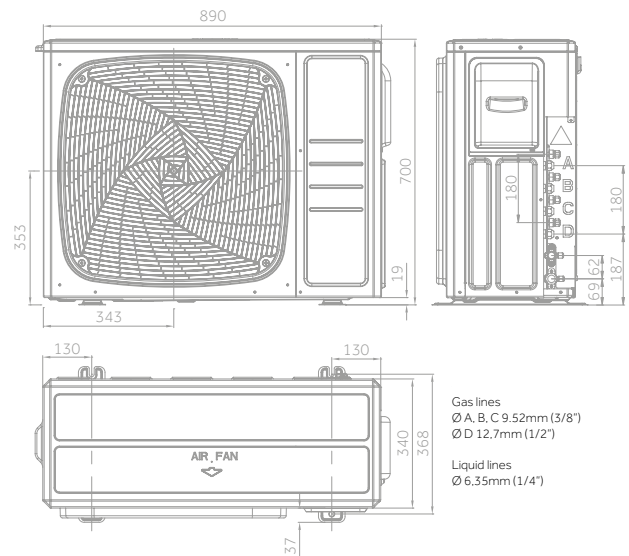
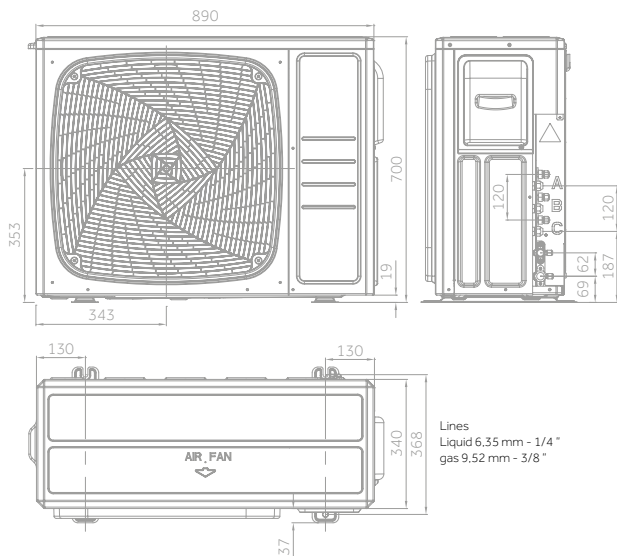

5U90S2SS5FA - 5U105S2SS5FA (5 coupling)

5U125S2SN1FA (5 coupling)

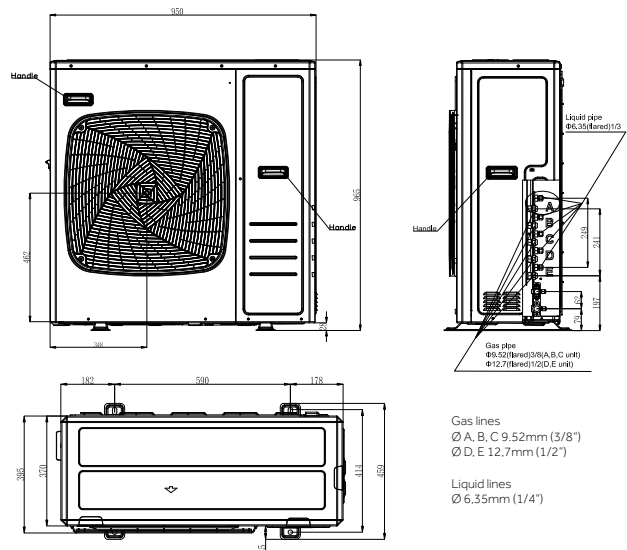
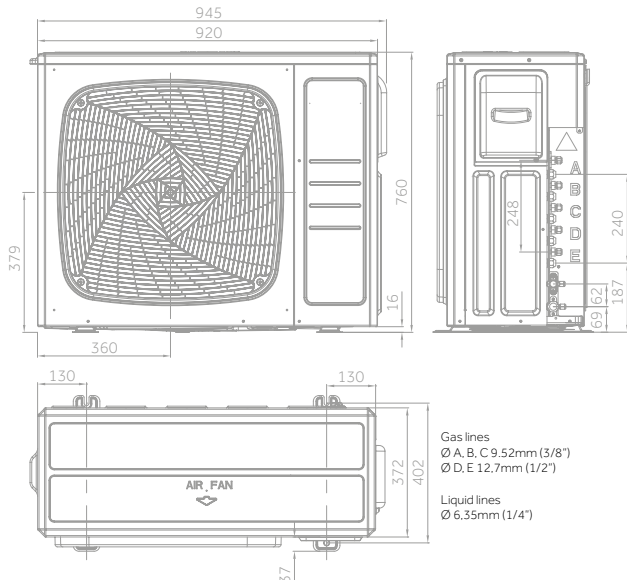

Haier
HVAC Solutions



MULTI

Residentiel MultiSplit Inverter



Haier HVAC
European HQ

Via Marconi, 96. 31020
Revine Lago (TV) - Italy
haierhvac.eu